

Operating instructions



ecoTEC plus

VU 446/5-5 (H-GB)

VU 606/5-5 (H-GB)

GB, IE, NZ

Publisher/manufacture

Vaillant GmbH

Berghauser Str. 40 | D-42859 Remscheid
Tel. +49 21 91 18-0 | Fax +49 21 91 18-2810
info@vaillant.de | www.vaillant.de



Contents

Contents

1	Safety	3	5.3	Draining the heating installation.....	14
1.1	Action-related warnings	3	5.4	Guaranteeing the correct filling pressure in the heating circuit.....	14
1.2	Intended use	3	5.5	Checking the condensate discharge pipe and tundish.....	16
1.3	General safety information.....	4	6	Troubleshooting	16
2	Notes on the documentation	8	6.1	Reading maintenance messages	16
2.1	Observing other applicable documents	8	6.2	Eliminating faults.....	16
2.2	Storing documents.....	8	6.3	Eliminating an ignition fault.....	16
2.3	Validity of the instructions.....	8	6.4	Displaying the status codes (Live Monitor).....	16
2.4	Benchmark.....	8	7	Decommissioning	16
3	Product description	9	7.1	Temporarily decommissioning the product.....	16
3.1	Product design.....	9	7.2	Permanently decommissioning the product.....	16
3.2	Displayed symbols.....	9	8	Recycling and disposal	16
3.3	Display	9	9	Guarantee and customer service	17
3.4	Protecting the heating installation against frost	10	9.1	Guarantee.....	17
3.5	Data plate	11	9.2	Customer service.....	17
3.6	CE label	11	Appendix	18	
3.7	Energy Saving Trust Endorsed Products.....	11	A	End user level – overview	18
4	Operation	12	B	Status codes – Overview	18
4.1	Operating concept	12	C	Fault codes	19
4.2	Adjustment and display levels	12	D	Troubleshooting	19
4.3	Basic display.....	12			
4.4	Menu display.....	13			
4.5	Starting up the product	13			
4.6	Setting the language.....	13			
4.7	Opening the isolator devices	13			
4.8	Setting the heating flow temperature	13			
4.9	Setting the domestic hot water temperature	13			
4.10	Switching off the product's functions	14			
5	Care and maintenance	14			
5.1	Caring for the product.....	14			
5.2	Maintenance	14			

1 Safety

1.1 Action-related warnings

Classification of action-related warnings

The action-related warnings are classified in accordance with the severity of the possible danger using the following warning signs and signal words:

Warning symbols and signal words



Danger!

Imminent danger to life or risk of severe personal injury



Danger!

Risk of death from electric shock



Warning.

Risk of minor personal injury



Caution.

Risk of material or environmental damage

1.2 Intended use

There is a risk of injury or death to the user or others, or of damage to the product and other property in the event of improper use or use for which it is not intended.

This product is a heat generator that has been specially de-

signed for closed heating installations.

Intended use includes the following:

- observance of the operating instructions included for the product and any other system components
- compliance with all inspection and maintenance conditions listed in the instructions.

This product can be used by children aged from 8 years and above and persons with reduced physical, sensory or mental capabilities or lack of experience and knowledge if they have been given supervision or instruction concerning use of the product in a safe way and understand the hazards involved. Children must not play with the product. Cleaning and user maintenance work must not be carried out by children unless they are supervised.

Any other use that is not specified in these instructions, or use beyond that specified in this document shall be considered improper use. Any direct commercial or industrial use is also deemed to be improper.

Caution.

Improper use of any kind is prohibited.

1 Safety

1.3 General safety information

1.3.1 Installation by competent persons only

The installation, inspection, maintenance and repair of the product, as well as the gas ratio settings, must only be carried out by a competent person.

1.3.2 Danger caused by improper operation

Improper operation may present a danger to you and others, and cause material damage.

- ▶ Carefully read the enclosed instructions and all other applicable documents, particularly the "Safety" section and the warnings.
- ▶ Only carry out the activities for which instructions are provided in these operating instructions.

1.3.3 Risk of death from escaping gas

Applicability: Except Great Britain, Except Ireland

What to do if you smell gas in the building:

- ▶ Avoid rooms that smell of gas.
- ▶ If possible, open doors and windows fully and ensure adequate ventilation.

- ▶ Do not use naked flames (e.g. lighters, matches).
- ▶ Do not smoke.
- ▶ Do not use any electrical switches, mains plugs, doorbells, telephones or other communication systems in the building.
- ▶ Close the emergency control valve or the main isolator.
- ▶ If possible, close the gas isolator cock on the product.
- ▶ Warn other occupants in the building by yelling or banging on doors or walls.
- ▶ Leave the building immediately and ensure that others do not enter the building.
- ▶ Alert the police and fire brigade as soon as you are outside the building.
- ▶ Use a telephone outside the building to inform the emergency service department of the gas supply company.

1.3.4 Risk of death from escaping gas

Applicability: Great Britain OR Ireland

What to do if you smell gas in the building:

- ▶ Avoid rooms that smell of gas.



- ▶ If possible, open doors and windows fully and ensure adequate ventilation.
- ▶ Do not use naked flames (e.g. lighters, matches).
- ▶ Do not smoke.
- ▶ Do not use any electrical switches, mains plugs, door-bells, telephones or other communication systems in the building.
- ▶ If it is safe to do so, close the emergency control valve or the main isolator.
- ▶ If possible, close the gas isolator cock on the product.
- ▶ Warn other occupants in the building by yelling or banging on doors or walls.
- ▶ Leave the building immediately and ensure that others do not enter the building.
- ▶ Notify the gas supply company or the National Grid +44 (0) 800 111999 by telephone once you are outside of the building.

1.3.5 Risk of death due to blocked or leaking flue pipework

What to do if you smell flue gas in the property:

- ▶ Open all accessible doors and windows fully to provide ventilation.
- ▶ Switch off the product.



- ▶ Inform a competent person.

1.3.6 Risk of death due to explosive and flammable materials

- ▶ Do not use the product in storage rooms that contain explosive or flammable substances (such as petrol, paper or paint).

1.3.7 Risk of death due to changes to the product or the product environment

- ▶ Never remove, bridge or block the safety devices.
- ▶ Do not tamper with any of the safety devices.
- ▶ Do not damage or remove any seals on components.
- ▶ Do not make any changes:
 - The product itself
 - to the gas, air, water and electricity supplies
 - to the entire flue gas installation
 - to the entire condensate drain system
 - to the expansion relief valve
 - to the drain pipework
 - to constructional conditions that may affect the operational reliability of the product

1 Safety

1.3.8 Risk of death due to cabinet-type casing

Cabinet-type casing can give rise to dangerous situations when used on a product which is operated with an open flue.

- ▶ Ensure that the product is supplied with sufficient combustion air.

1.3.9 Risk of poisoning caused by insufficient combustion air supply

Conditions: Open-flued operation

- ▶ Ensure that there is a sufficient combustion air supply.

1.3.10 Risk of corrosion damage due to unsuitable combustion and room air

Sprays, solvents, chlorinated cleaning agents, paint, adhesives, ammonia compounds, dust or similar substances may lead to corrosion on the product and in the air/flue pipe.

- ▶ Ensure that the supply of combustion air is always free of fluorine, chlorine, sulphur, dust, etc.
- ▶ Ensure that no chemical substances are stored at the installation site.

1.3.11 Risk of material damage caused by frost

- ▶ Ensure that the heating installation always remains in operation during freezing conditions and that all rooms are sufficiently heated.
- ▶ If you cannot ensure the operation, have a competent person drain the heating installation.

1.3.12 Risk of injury and material damage due to maintenance and repairs carried out incorrectly or not carried out at all

- ▶ Never attempt to carry out maintenance work or repairs on your product yourself.
- ▶ Faults and damage should be immediately rectified by a competent person.
- ▶ Adhere to the maintenance intervals specified.

1.3.13 Starting up the product

- ▶ Only start up the product once the casing has been completely closed.

1.3.14 Risk of material damage

The product's casing is not designed to withstand loads. There is a risk that it will be-



come deformed due to the effect of bearing weight.

- ▶ Do not place any objects on the product.



2 Notes on the documentation

2 Notes on the documentation

2.1 Observing other applicable documents

- ▶ You must observe all operating instructions enclosed with the system components.

2.2 Storing documents

- ▶ Keep this manual and all other applicable documents safe for future use.

2.3 Validity of the instructions

These instructions apply only to:

Product article number

VU 446/5-5 (H-GB) ecoTEC plus	0010021520
VU 606/5-5 (H-GB) ecoTEC plus	0010021521

Gas Council Number

VU 446/5-5 (H-GB) ecoTEC plus	41-694-28
VU 606/5-5 (H-GB) ecoTEC plus	41-694-29

2.4 Benchmark

Applicability: Great Britain



Vaillant is a licensed member of the Benchmark Scheme which aims to improve the standards of installation and commissioning of domestic heating and hot water systems in the UK and to encourage regular servicing to optimise safety, efficiency and performance.

Benchmark is managed and promoted by the Heating and Hotwater Industry

Council. For more information visit www.benchmark.org.uk.

- ▶ Please ensure that the installer has fully completed the Benchmark Checklist on the inside back pages of the installation instructions supplied with the product and that you have signed it to say that you have received a full and clear explanation of its operation. The installer is legally required to complete a commissioning checklist as a means of complying with the appropriate Building Regulations (England and Wales).

All installations must be notified to Local Area Building Control either directly or through a Competent Persons Scheme. A Building Regulations Compliance Certificate will then be issued to the customer who should, on receipt, write the Notification Number on the Benchmark Checklist. This product should be serviced regularly to optimise its safety, efficiency and performance. The service engineer should complete the relevant Service Record on the Benchmark Checklist after each service.

The Benchmark Checklist will be required in the event of any warranty.

Product description 3

3 Product description

3.1 Product design

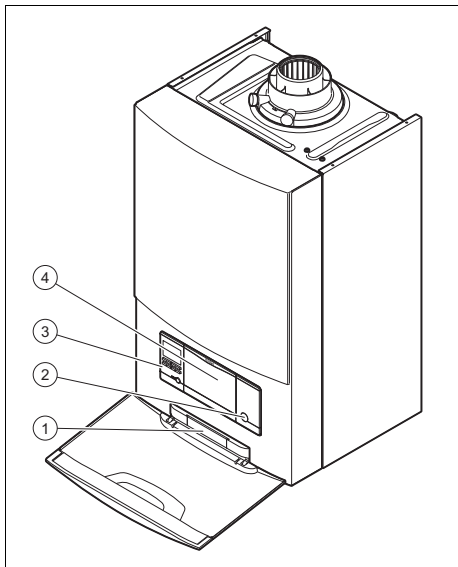

- | | |
|--|---|
| 1 Plate with serial number on the rear | 3 Operator control element |
| 2 On and off button | 4 Installation location for the optional control system |

3.2 Displayed symbols

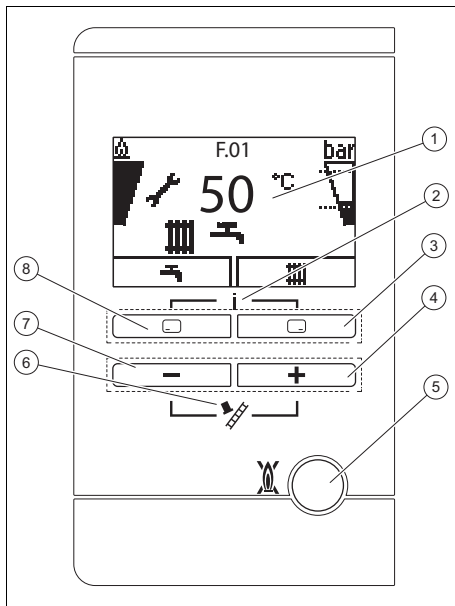

- | | |
|---|---|
| 1 Display | 5 Reset button |
| 2 Access to the menu for additional information | 6 Chimney sweep mode (for chimney sweeps) |
| 3 Right selection button | 7 button |
| 4 button | 8 Left selection button |



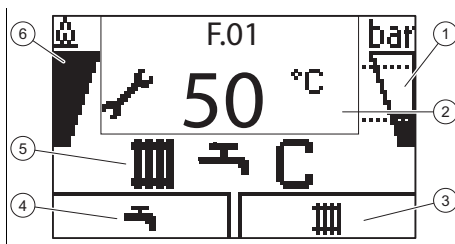



3.3 Display



- | | |
|--|---|
| 1 Heating installation filling pressure | 3 Current assignment of the right-hand selection button |
| 2 Current heating flow temperature, additional information | |

3 Product description

- 4 Current assignment of the left-hand selection button
- 5 Active operating mode
- 6 Burner information

Symbol	Meaning	Explanation
	Burner operating correctly	Burner on
	Current filling pressure of the heating installation The dashed lines show the permitted range.	<ul style="list-style-type: none"> – Permanently on: Filling pressure in the permitted range – Flashing: Filling pressure outside the permitted range
	Domestic hot water generation active	<ul style="list-style-type: none"> – Permanently on: Draw-off mode before burner is on – Flashing: Burner on in draw-off mode
	Heating mode active	<ul style="list-style-type: none"> – Permanently on: Heat demand in heating mode – Flashing: Burner on in heating mode
	Maintenance required	Information on the maintenance message in the "Live Monitor"
	Summer mode active Heating mode is switched off	
	Burner anti-cycling time is active	To avoid the need for frequent switching on and off (increases the product's service life).

Symbol	Meaning	Explanation
 F.XX	Fault in the product	Appears instead of the basic display, may be an explanatory plain text display.

3.4 Protecting the heating installation against frost

3.4.1 Frost protection function



Caution.

Risk of material damage due to frost.

The frost protection function cannot guarantee circulation through the entire heating installation. Under certain circumstances, there is therefore a risk of frost to certain parts of the heating installation, which may cause damage.

- During a period of frost, ensure that the heating installation remains in operation and that all rooms are sufficiently heated, even when you are away.



Note

To ensure that the frost protection devices remain ready for operation, the boiler must be switched on.

If the heating flow temperature falls below 5 °C when the on/off button is switched on, the product starts up and heats the circulating water on the heating side to approx. 30 °C.

3.5 Data plate

The data plate is mounted on the underside of the product in the factory.

Information on the data plate	Meaning
	Barcode with serial number
Serial number	For quality control purposes; 3rd and 4th digits = year of production For quality control purposes; 5th and 6th digits = week of production For identification purposes; 7th to 16th digits = product article number For quality control purposes; 17th to 20th digits = place of manufacture
... ecoTEC Plus ...	Product designation
2H / 2E / 3P / 2L...	Gas group and gas connection pressure as set at the factory
I12H3P / I2E / I3P...	Approved gas category
Condensing technology	Efficiency class of the boiler in accordance with EC Directive 92/42/EEC
Type: Xx3(x)	Permissible flue gas connections
PMS	Maximum water pressure in heating mode
V Hz	Electrical connection – Voltage – Frequency
Hi	Lower gross calorific value
W	Max. electrical power consumption
IP	Protection class
III	Heating mode
Qn	Nominal heating load range in heating mode
Pn	Nominal heat output range in heating mode

Information on the data plate	Meaning
Pnc	Nominal heat output range in heating mode (condensing technology)
Tmax	Maximum flow temperature
NOx	NOx class for the product
Code (DSN)	Specific product code
	Read the instructions.



Note

Make absolutely sure that the product is compatible with the gas group at the installation site.

3.6 CE label



The CE label shows that the products comply with the basic requirements of the applicable directives as stated on the identification plate.

The declaration of conformity can be viewed at the manufacturer's site.

3.7 Energy Saving Trust Endorsed Products

Applicability: Great Britain



Only the most energy efficient products can carry the 'Energy Saving Trust Endorsed Product' brandmark making it easy for consumers to choose products that have met strict energy performance criteria.

Available for: Boilers, Heating controls and chemical inhibitors, the Energy Saving Trust endorsed product brandmark gives consumers confidence that a product will cost less to run, help lower energy bills and reduce carbon emissions.

4 Operation

About the Energy Saving Trust

Energy Saving Trust is an independent and impartial organisation that provides trusted energy saving advice to empower millions of people to lead affordable, low energy lifestyles. For more information visit energysavingtrust.org.uk

4 Operation

4.1 Operating concept

Op-er-ator control element	Operation
<input type="checkbox"/>	<ul style="list-style-type: none"> - Setting the domestic hot water temperature - Cancelling the activation of an operating mode - Cancelling a change to a set value - Going one selection level higher
<input type="checkbox"/>	<ul style="list-style-type: none"> - Setting the heating flow temperature - Reading the system pressure - Activating the comfort mode - Activating the operating mode - Confirm set value - Going one selection level lower
<input type="checkbox"/> + <input type="checkbox"/> at the same time	<ul style="list-style-type: none"> - Calling up the menu
<input type="checkbox"/> or <input type="checkbox"/>	<ul style="list-style-type: none"> - Reducing or increasing the set value - Scrolling through menu entries

The current function of the and buttons is shown in the display.

Adjustable values are always displayed as flashing.

You must always confirm a change to a value. Only then is the new setting saved. You can use the button to cancel a process at any time.

4.2 Adjustment and display levels

The product has two adjustment and display levels.

The end user level contains information and setting options that you require as the end user.

The installer level is reserved for the competent person. It is protected by a code. Only competent persons may change any settings in the installer level.

End user level – overview (→ Page 18)

4.3 Basic display

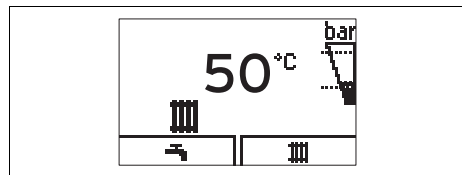

The basic display shows the current condition of the product. If you press a selection button, the activated function is displayed in the display.

Which of these functions is available depends on whether a control is connected to the product.

You can switch back to the basic display by:

- Press to exit the selection level
- Not pressing any button for longer than 15 minutes.

If there is an error message present, the basic displays switches to the error message.

4.4 Menu display

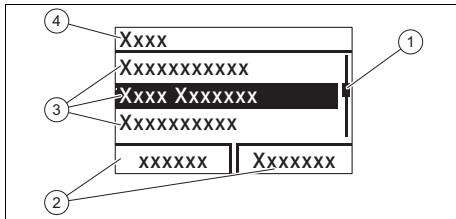

- | | |
|--|--------------------------------|
| 1 Scroll bar | 3 Selection level list entries |
| 2 Current assignment of the and buttons. | 4 Name of the selection level |

You can find an overview of the menu structure in the appendix.

End user level – overview (→ Page 18)

4.5 Starting up the product

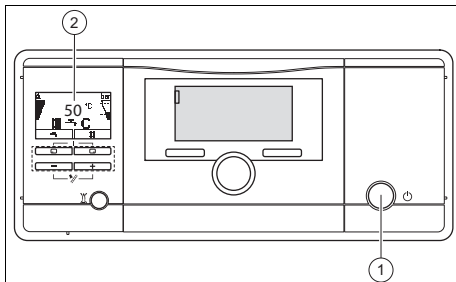

- ▶ Press the on/off button (1).
- ◁ The "Basic display" appears in the display (2).

4.6 Setting the language

1. Press and hold the and buttons at the same time.
2. Also briefly press .
3. Press and hold the and buttons until the display shows the language setting.
4. Select the required language by pressing or .
5. Confirm by pressing .
6. Once you have set the correct language, press again to confirm this.

4.7 Opening the isolator devices

1. Ask the competent person who installed the product to explain to you where these isolator devices are located and how to handle them.
2. Open the gas stopcock fully.
3. Open the service valves in the heating installation's flow and return.

Applicability: Product with connected domestic hot water cylinder

- ▶ Open the cold-water isolation valve.

4.8 Setting the heating flow temperature



Note

The product has test devices for the air and water flow rate, which use a waiting period of max. one minute for each heat demand before the heating starts.

Conditions: The unit is not connected to an external or internal control

- ▶ Press (M).
- ◁ The target value of the heating flow temperature appears on the display.



Note

The competent person may have adjusted the maximum possible temperature.

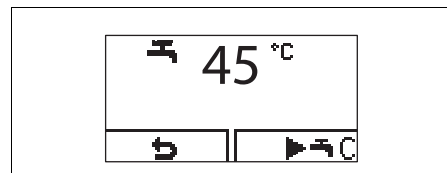

4.9 Setting the domestic hot water temperature

Conditions: If an external domestic hot water cylinder is connected to the boiler and a cylinder temperature sensor is connected.







- ▶ Press the button (hot water tap).

5 Care and maintenance



- ◁ The set target hot water temperature that is set flashes on the display.
- ▶ Change the domestic hot water temperature by pressing  or .
- ▶ Press  to confirm this change.

4.10 Switching off the product's functions

4.10.1 Switching off heating mode (Summer mode)

1. To switch off heating mode without switching off the domestic hot water generation, press  (III).
 - ◁ The value of the heating flow temperature appears in the display.
2. Use the  button to set the heating flow temperature to **Heating off**.
3. Confirm by pressing .
 - ◁ Heating mode is switched off
 - ◁ The  symbol appears in the display.

4.10.2 Deactivating the domestic hot water generation

1. To deactivate cylinder charging while leaving heating mode active, press  (II).
 - ◁ The set domestic hot water temperature flashes in the display.
2. Use the  button to set the domestic hot water temperature to **Heating off**.
3. Confirm by pressing .
 - ◁ Cylinder charging is switched off.
 - ◁ Only the cylinder's frost protection function remains active.

5 Care and maintenance

5.1 Caring for the product

- ▶ Clean the casing with a damp cloth and a little solvent-free soap.
- ▶ Do not use sprays, scouring agents, detergents, solvents or cleaning agents that contain chlorine.

5.2 Maintenance

Applicability: Except Great Britain

An annual inspection and biennial maintenance of the product carried out by a competent person is a prerequisite for ensuring that the product is permanently ready and safe for operation, reliable, and has a long service life. The inspection may require maintenance to be carried out earlier, depending on the results.

Applicability: Great Britain

An annual inspection of the product carried out by a competent person is a prerequisite for ensuring that the product is permanently ready and safe for operation, reliable, and has a long working life.

5.3 Draining the heating installation

When the unit is switched off for an extended period, frost protection can be guaranteed by completely draining the heating installation and the product.

- ▶ Consult a competent person about this.

5.4 Guaranteeing the correct filling pressure in the heating circuit

5.4.1 Heating installation filling pressure

If the heating installation's filling pressure falls below a value of 0.05 MPa (0.5 bar), the product switches off. The display alternates between fault message F.22 and the current filling pressure. In addition,

the  symbol appears after approx. one minute.

5.4.2 Checking the filling pressure of the heating installation

1. Press  twice.
 - ◁ The values for the current filling pressure and for the minimum and maximum filling pressures appear in the display.

2. Alternatives 1 / 2

Conditions: The heating installation's filling pressure is correct

- ▶ Check the filling pressure in the display.
Recommended filling pressure range: 0.15 ... 0.25 MPa (1.50 ... 2.50 bar)
The filling pressure is within the recommended pressure range.

2. Alternatives 2 / 2

Conditions: Filling pressure in the heating installation is too low.

- ▶ Fill the heating installation.
 - ◁ If the heating installation extends over several storeys, a higher filling pressure may be required for the heating installation. Ask a competent person for details.
 - ◁ If you have topped up the installation with sufficient heating water, the fault message automatically disappears after approx. 20 seconds.

5.4.3 Filling the heating installation



Caution.

Risk of material damage due to heating water that is extremely calciferous or corrosive or contaminated by chemicals.

Unsuitable tap water damages the seals and diaphragms, blocks components in the product and heating installation through which the water flows and causes noise.

- ▶ Only fill the heating installation with suitable heating water.

1. Ask a competent person where the filling tap is located.
2. Connect the filling tap to a heating water supply in the way you were told by the competent person.
3. Open all radiator valves (thermostatic valves) of the heating installation.
4. Open the heating water supply.
5. Turn the filling tap on slowly and allow water to flow in until the required filling pressure has been reached.
6. Close the heating water supply.
7. Purge all radiators.
8. Check the filling pressure in the display.
9. Top up with more water if necessary.
10. Close the filling tap.
11. Return to the basic display.

6 Troubleshooting

5.5 Checking the condensate discharge pipe and tundish

The condensate discharge pipe and tundish must always be penetrable.

- ▶ Regularly check the condensate discharge pipe and tundish for faults and, particularly, for blockages.

You must not be able to see or feel any obstructions in the condensate discharge pipe and tundish.

- ▶ If you notice a fault, have it eliminated by a competent person.

6 Troubleshooting

6.1 Reading maintenance messages

If the  symbol is shown in the display, the product requires maintenance work.

The product is not in fault mode; it is operating normally.

- ▶ Consult a competent person about this.
- ▶ If the water pressure is flashing at the same time, simply add more heating water.

6.2 Eliminating faults

- ▶ If faults occur, proceed in accordance with the table in the appendix. Troubleshooting (→ Page 19)
- ▶ If the fault cannot be eliminated using the specified measures or if fault messages (F.xx) occur, contact a competent person.



6.3 Eliminating an ignition fault

If the burner fails to ignite after five ignition attempts, the product does not operate and switches to "Fault". This is indicated by the fault code F.28 or F.29 in the display.

The product will only ignite automatically again once you have eliminated the fault manually.

- ▶ Ensure that the gas stopcock is open.
- ▶ Press the reset button to reset the unit.
- ▶ Contact a competent person if the ignition problem is not eliminated after three reset attempts.

6.4 Displaying the status codes (Live Monitor)

- ▶ Press  and  at the same time. Status codes – Overview (→ Page 18)
 - ◀ The current operating mode (status code) is shown on the display.

7 Decommissioning

7.1 Temporarily decommissioning the product

Temporarily decommission the product only if there is no risk of frost.

- ▶ Press the on/off button.
 - ◀ The display goes out.
- ▶ When decommissioning the product for a prolonged period (e.g. holiday), close the gas stopcock and also, for combination products, the cold-water isolation valve.

7.2 Permanently decommissioning the product

- ▶ Employ a competent person to permanently decommission the product.

8 Recycling and disposal

- ▶ The competent person who installed your product is responsible for the disposal of the packaging.



If the product is labelled with this mark:

- ▶ In this case, do not dispose of the product with the household waste.

Guarantee and customer service 9

- ▶ Instead, hand in the product to a collection centre for waste electrical or electronic equipment.



If the product contains batteries that are labelled with this mark, these batteries may contain substances that are hazardous to human health and the environment.

- ▶ In this case, dispose of the batteries at a collection point for batteries.

9 Guarantee and customer service

9.1 Guarantee

Applicability: New Zealand

For information on the manufacturer's guarantee, you can write to the contact address that is provided on the back page.

Applicability: Great Britain
OR Ireland

- Five year guarantee for ecoTEC plus appliances

Vaillant undertakes to rectify any manufacturing defect that occurs within a five year period of the installation date/manufacturing date (if the installation date cannot be determined) provided that: An annual service has been carried out by a competent person approved at the time by the Health and Safety Executive. The cost of these services is not included in the guarantee. The water flowing through the boiler is maintained with adequate and appropriate inhibitors. Any additional guarantee applies only if the boiler and system has been maintained as above and the boiler is protected from the system by a plate heat exchanger. If there is no evidence that the boiler and system has been maintained in an appropriate manner the standard 1yr guarantee applies. Your statutory rights are unaffected.

- Registering with us

Registration is simple. Just complete the Guarantee Registration Card and return to Vaillant within 30 days of installation. Your details will then be automatically registered within the Vaillant scheme.

- Immediate help

If your Vaillant boiler develops a fault your first action should be to contact your installer, as his professional assessment is needed under the terms of our Guarantee. If you are unable to contact your installer, phone Vaillant Service Solutions:

Telephone: 0330 100 3461

9.2 Customer service

Applicability: New Zealand

For contact details for our customer service department, you can write to the address that is provided on the back page, or you can visit www.vaillant.com.

Applicability: Great Britain
OR Ireland

To ensure efficient and reliable operation of your boiler it is recommended that regular servicing is carried out by your service provider.

Appendix

Appendix

A End user level – overview

Setting level	Values		Unit	Increment, select	Default setting
	Min.	Max.			
Water pressure →					
Water pressure	Current value		bar		
Live monitor →					
Status	Current value				
Information →					
Contact details	Phone number				
Serial number	Permanent value				
Display contrast	Current value			1	25
	15	40			
Basic settings →					
Language	Current language			Languages available for selection	Country-specific
Resets →					
Reset anti-cycl. time	Current value		min		

B Status codes – Overview

Status codes that are not listed here can be viewed in the installation instructions.

Status code	Meaning
Heating mode	
S.00	Heating demand
S.01	Heating mode: Fan start-up
S.02	Heating mode: Pump start-up
S.03	Heating mode: Ignition
S.04	Heating mode: Burner on
S.05	Heating mode: Pump/fan overrun
S.06	Heating mode: Fan reduction
S.07	Heating mode: Pump overrun
S.08	Heating mode, burner anti-cycling time
Cylinder charging mode	
S.20	Domestic hot water requirement
S.21	DHW mode: Fan start-up
S.22	Domestic hot water mode: Pump running

Status code	Meaning
S.23	DHW mode: Ignition
S.24	DHW mode: Burner on
S.25	DHW mode: Pump/fan overrun
S.26	DHW mode: Fan overrun
S.27	DHW mode: Pump overrun
S.28	Domestic hot water burner anti-cycling time
Other displays	
S.30	Room thermostat (RT) is blocking heating mode
S.31	Summer mode active or eBUS controller is blocking heating mode
S.34	Frost protection active
S.85	Service message "Insufficient water flow rate, product in standby mode for 10 minutes"

C Fault codes

Message	Possible cause	Measure
F.22 System pressure too low	The system pressure is too low. Water deficiency in the heating installation.	► Fill the heating installation.
F.28 Ignition unsuccessful	After five unsuccessful ignition attempts, the product has switched to fault mode.	<ol style="list-style-type: none"> 1. Check whether the gas stopcock is open. 2. Check whether the siphon is free. 3. Check whether the flue is free. 4. Press and hold the reset button for one second. <ul style="list-style-type: none"> – Reset attempts: ≤ 5 5. If you have been unable to eliminate the ignition fault after the reset attempt, consult a competent person.

D Troubleshooting

Fault	Cause	Measure
Product does not start up: – No domestic hot water – Heating does not heat up	The gas stopcock installed on-site and/or the gas stopcock on the product is closed.	Open both gas stopcocks.
	The power supply in the building is disconnected.	Check the fuse in the building. The product automatically switches on after the power supply is restored.
	The product is switched off.	Switch on the product (→ "Switching on the product" section).

Appendix

Fault	Cause	Measure
Product does not start up: – No domestic hot water – Heating does not heat up	The heating flow temperature is set too low or to the Heating off position, and/or the domestic hot water temperature is set too low.	Set the heating flow temperature and domestic hot water temperature (→ "Setting the heating flow temperature" section/→ "Setting the domestic hot water temperature" section).
	The system pressure is insufficient. Water deficiency in the heating installation (fault message: F.22).	Fill the heating installation (→ "Filling the heating installation" section).
	There is air in the heating installation.	Have your competent person purge the heating installation.
	After five unsuccessful ignition attempts, the product switches to fault mode (fault message: F.28).	Press the reset button for one second. The product carries out a new ignition attempt. If the ignition problem is not eliminated after three reset attempts, contact a competent person.
	The hydraulic circuit is closed	Ensure that the stopcocks for the hydraulic circuit(s) are open
Domestic hot water generation functioning correctly; heating does not start up.	The external control is not set correctly.	Set the external control correctly (→ Control operating instructions).

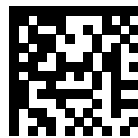

0020261390_01

0020261390_01 ■ 02.11.2017

Supplier

Vaillant Ltd.

Nottingham Road ■ Belper ■ Derbyshire ■ DE56 1JT

Telephone 0330 100 3461

info@vaillant.co.uk ■ www.vaillant.co.uk

Vaillant Group International GmbH

Berghauser Strasse 40 ■ 42859 Remscheid

Tel. +49 21 91 18-0

www.vaillant.info

© These instructions, or parts thereof, are protected by copyright and may be reproduced or distributed only with the manufacturer's written consent.

We reserve the right to make technical changes.